

Hong Kong Houseware Fair

香港家庭用品展

3M x 3M WORLD OF FINE DINING BOOTH

三米乘三米標準攤位

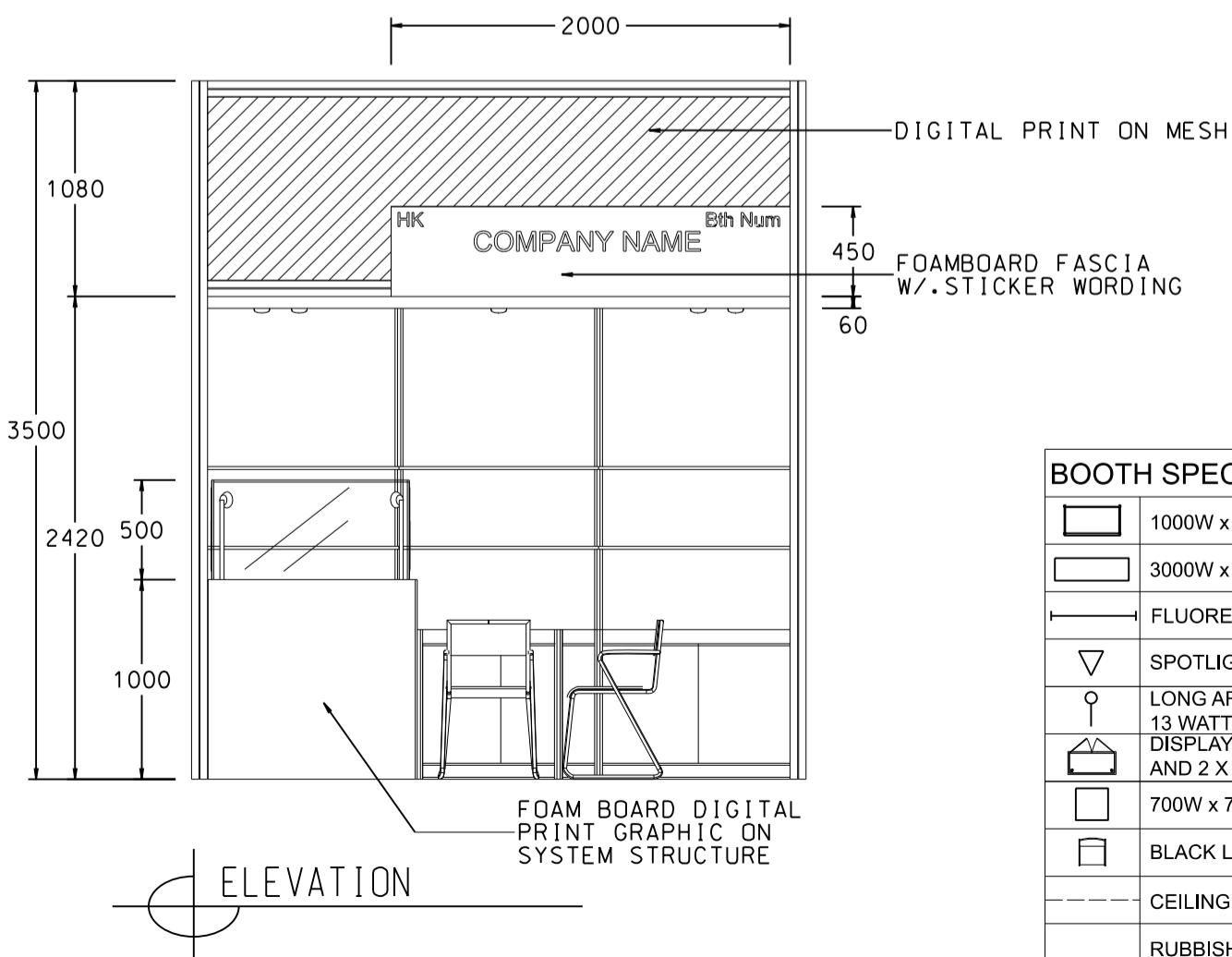
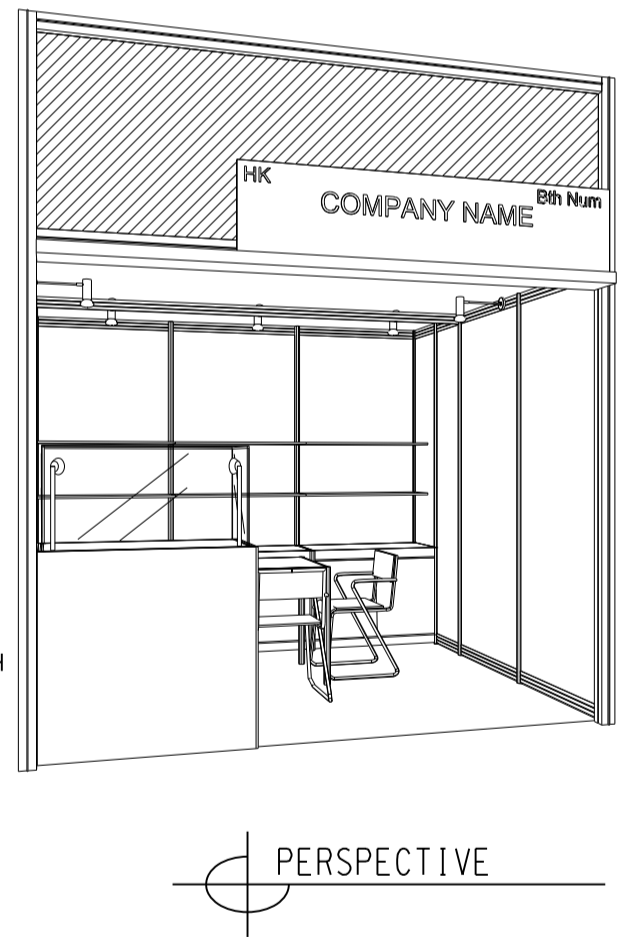
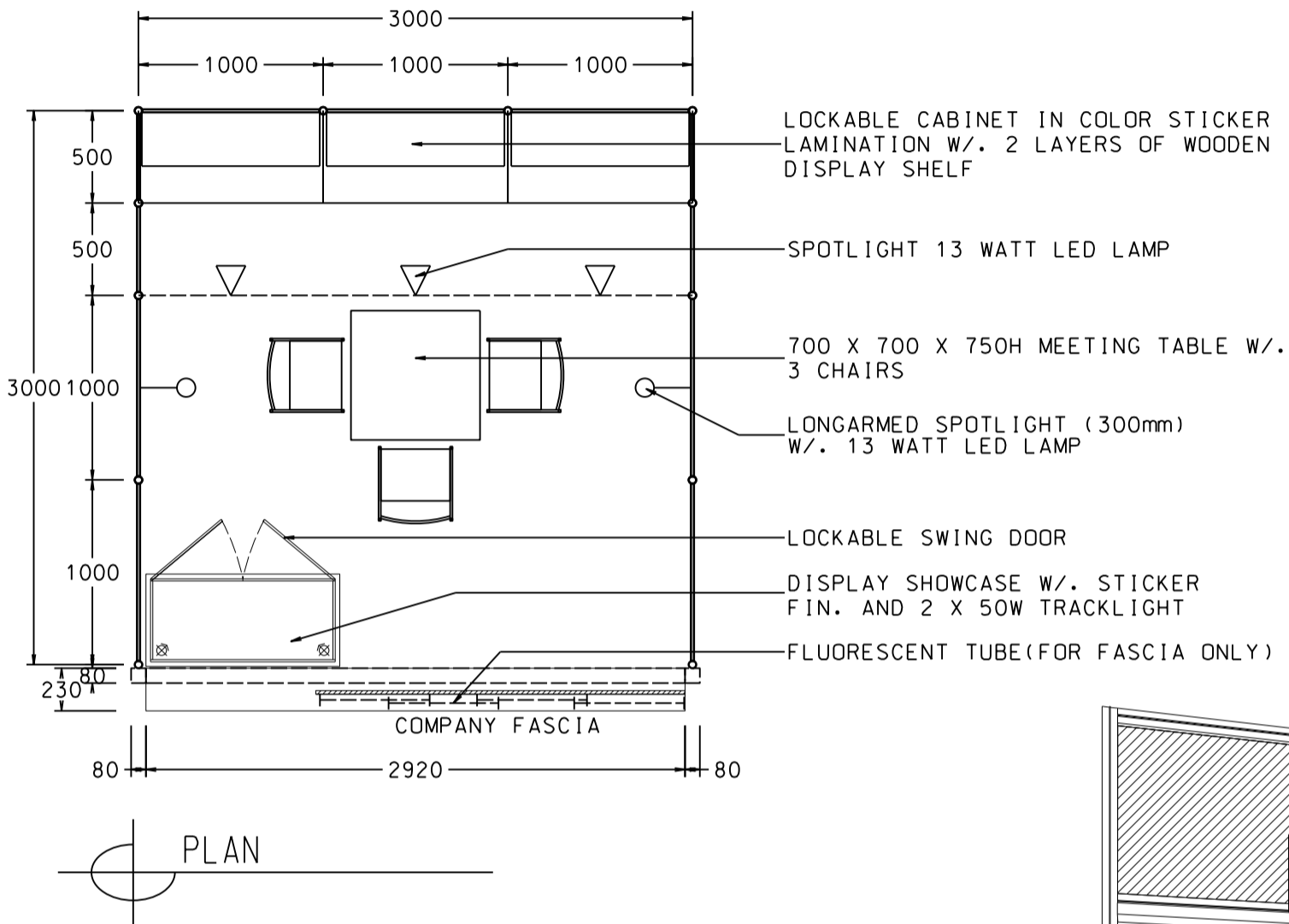

BOOTH SPECIFICATIONS		QTY.
	1000W x 500D x 750H LOCKABLE CABINET	3
	3000W x 300D WOODEN DISPLAY SHELF	2
	FLUORESCENT TUBE (FOR FASCIA ONLY)	4
	SPOTLIGHT 13 WATT LED LAMP (YELLOW LIGHT)	3
	LONG ARMED SPOTLIGHT (300MM) 13 WATT LED LAMP (YELLOW LIGHT)	2
	DISPLAY SHOWCASE W/. STICKER FIN. AND 2 X 50W TRACKLIGHT	1
	700W x 700D x 750H MEETING TABLE	1
	BLACK LEATHER CHAIR	3
	CEILING BEAM	3M
	RUBBISH BIN & CARPET (9sqm.)	

*The Hong Kong Trade Development Council reserves the right to change the configuration if necessary.

*如有需要，香港貿易發展局有權更改攤位結構。

Hong Kong Houseware Fair

香港家庭用品展

3M x 3M WORLD OF FINE DINING LEFT CORNER BOOTH

三米乘三米左邊角位攤位

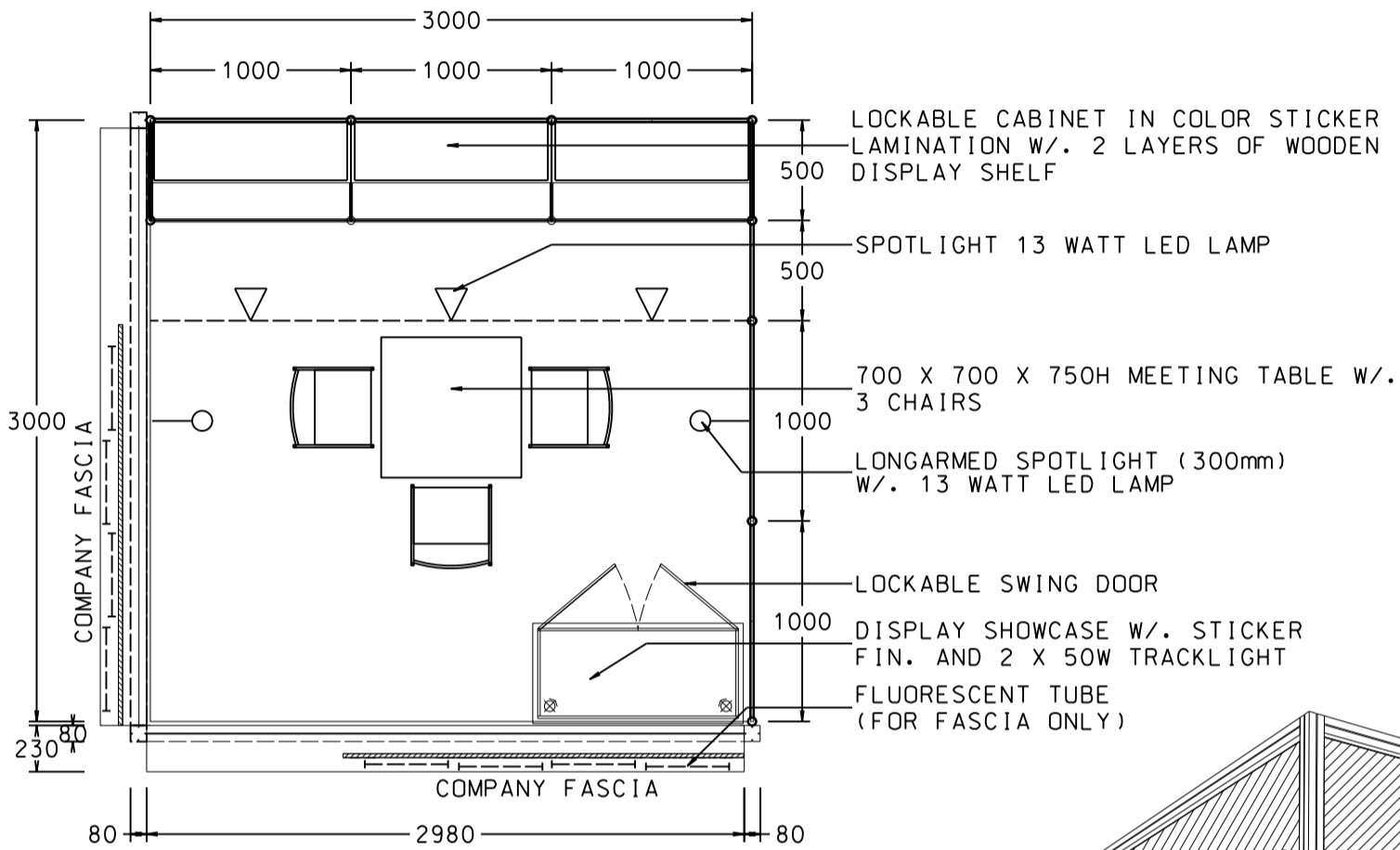

PLAN

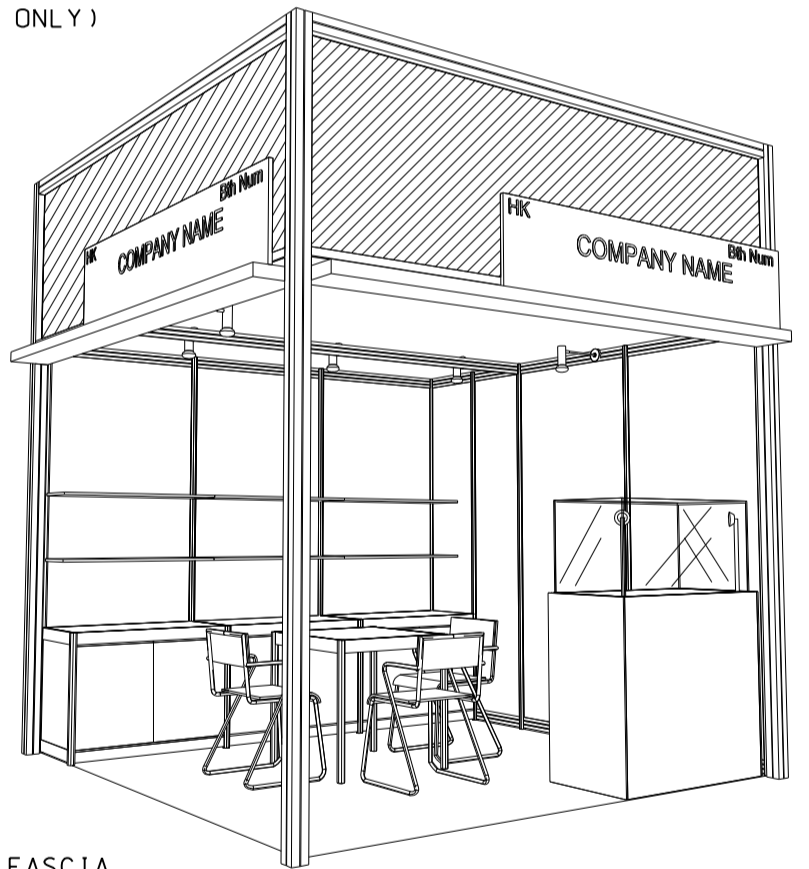

PERSPECTIVE

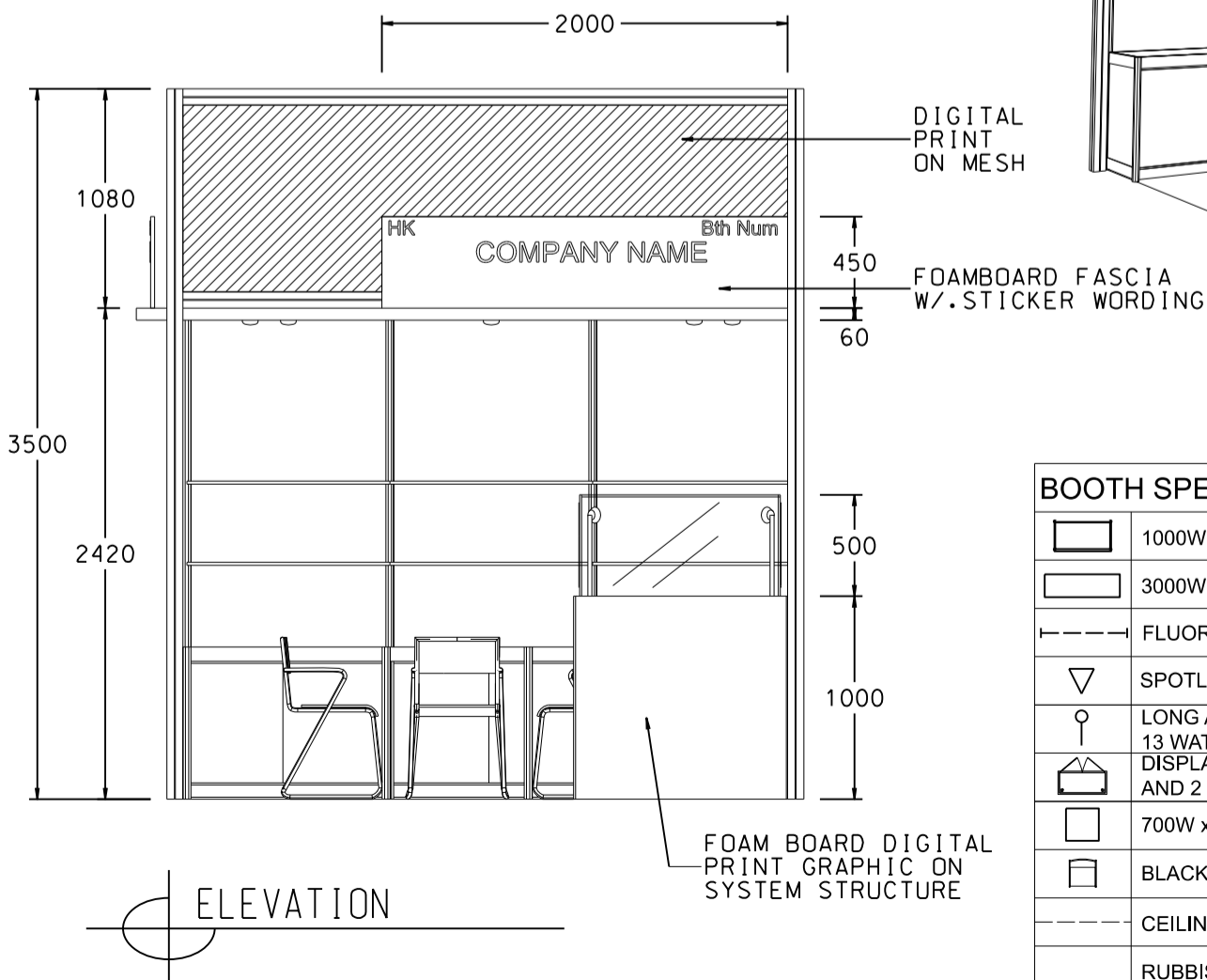

ELEVATION

BOOTH SPECIFICATIONS		QTY.
	1000W x 500D x 750H LOCKABLE CABINET	3
	3000W x 300D WOODEN DISPLAY SHELF	2
	FLUORESCENT TUBE (FOR FASCIA ONLY)	8
	SPOTLIGHT 13 WATT LED LAMP (YELLOW LIGHT)	3
	LONG ARMED SPOTLIGHT (300MM) 13 WATT LED LAMP (YELLOW LIGHT)	2
	DISPLAY SHOWCASE W/. STICKER FIN. AND 2 X 50W TRACKLIGHT	1
	700W x 700D x 750H MEETING TABLE	1
	BLACK LEATHER CHAIR	3
	CEILING BEAM	3M
	RUBBISH BIN & CARPET (9sqm.)	

*The Hong Kong Trade Development Council reserves the right to change the configuration if necessary.

*如有需要，香港貿易發展局有權更改攤位結構。

Hong Kong Houseware Fair

香港家庭用品展

3M x 3M WORLD OF FINE DINING LEFT CORNER BOOTH (UNDER FIRE CURTAIN)

三米乘三米左邊角位攤位(防火閘下)

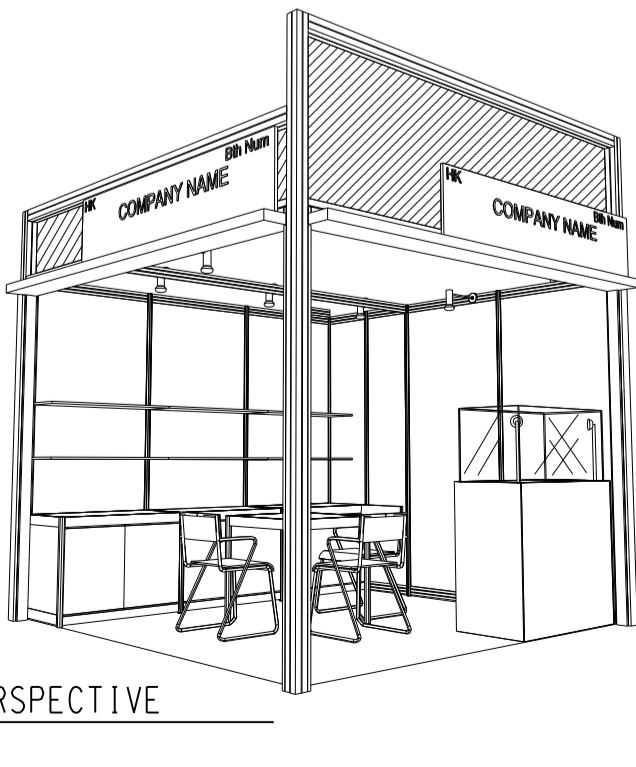
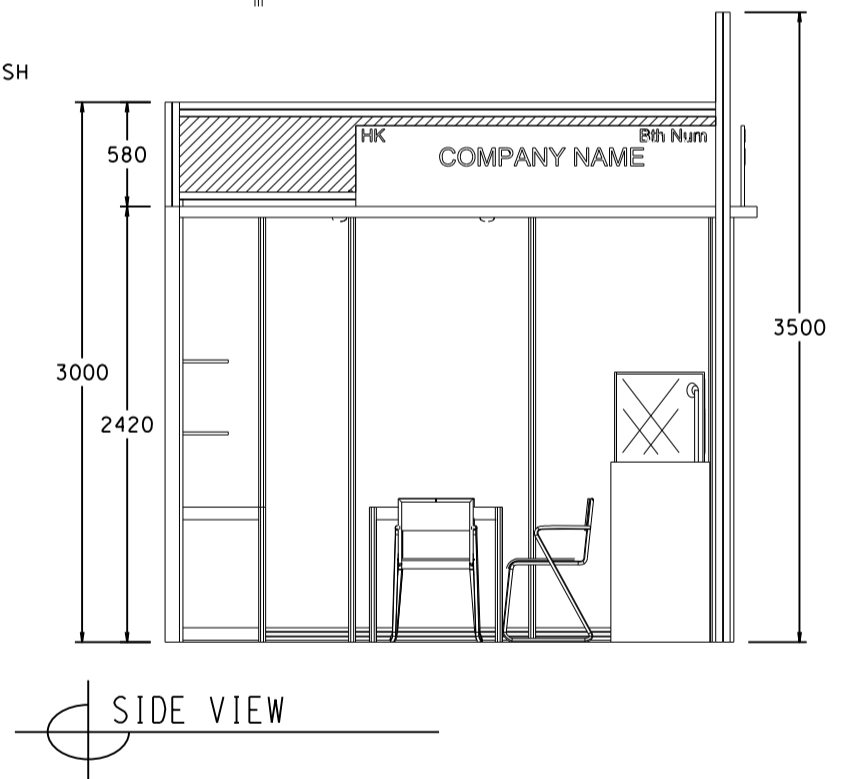
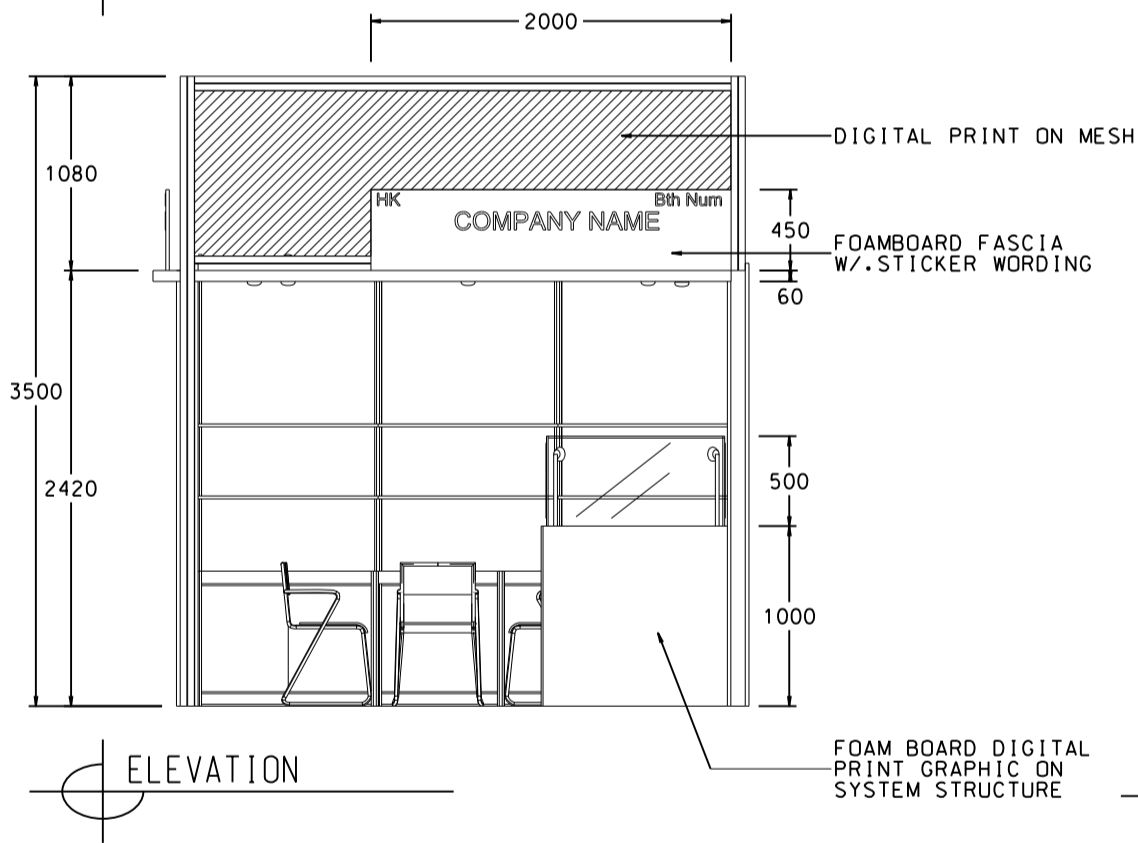
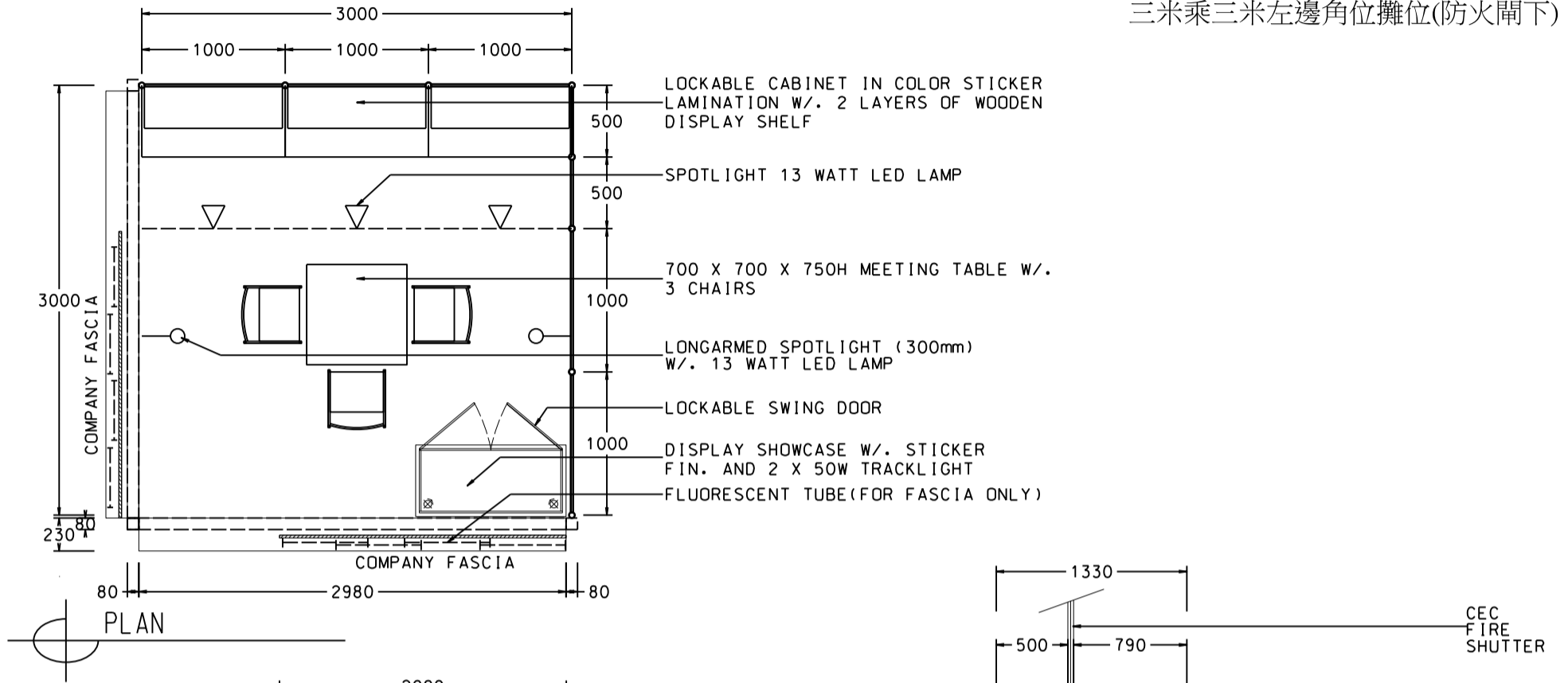

BOOTH SPECIFICATIONS		QTY.
	1000W x 500D x 750H LOCKABLE CABINET	3
	3000W x 300D WOODEN DISPLAY SHELF	2
	FLUORESCENT TUBE (FOR FASCIA ONLY)	8
	SPOTLIGHT 13 WATT LED LAMP (YELLOW LIGHT)	3
	LONG ARMED SPOTLIGHT (300MM) 13 WATT LED LAMP (YELLOW LIGHT)	2
	DISPLAY SHOWCASE W/. STICKER FIN. AND 2 X 50W TRACKLIGHT	1
	700W x 700D x 750H MEETING TABLE	1
	BLACK LEATHER CHAIR	3
	CEILING BEAM	3M
	RUBBISH BIN & CARPET (9sqm.)	

*The Hong Kong Trade Development Council reserves the right to change the configuration if necessary.

*如有需要，香港貿易發展局有權更改攤位結構。

Hong Kong Houseware Fair

香港家庭用品展

3M x 3M WORLD OF FINE DINING RIGHT CORNER BOOTH

三米乘三米右邊角位攤位

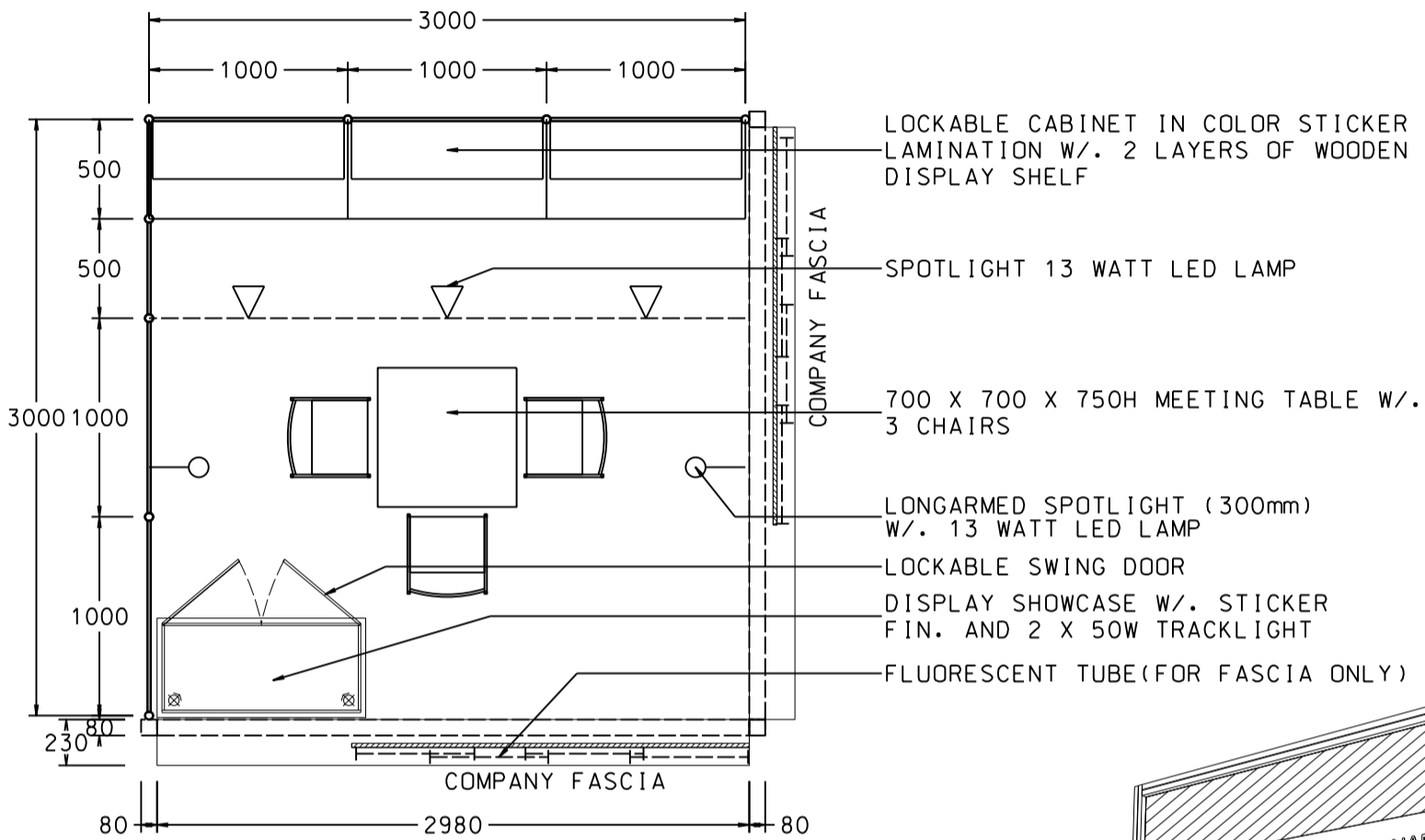

PLAN

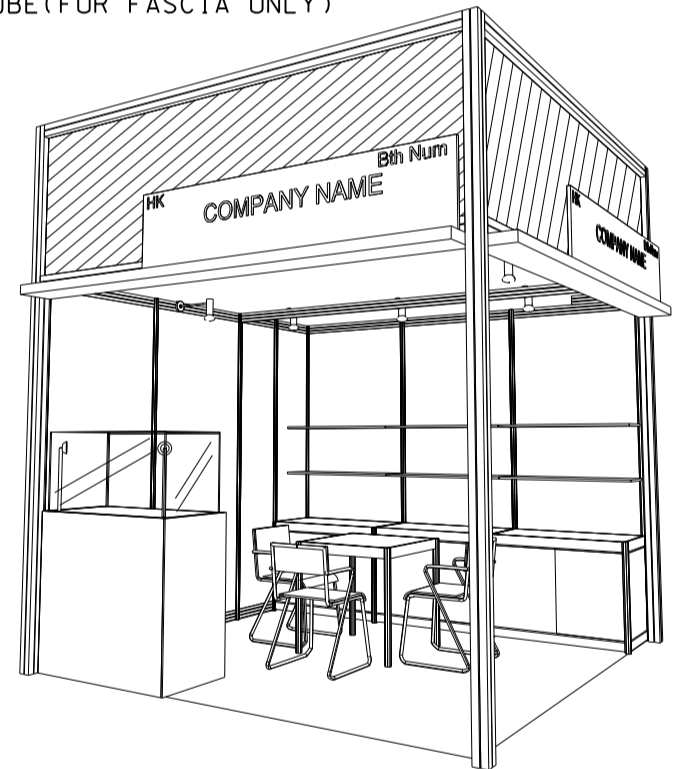

PERSPECTIVE

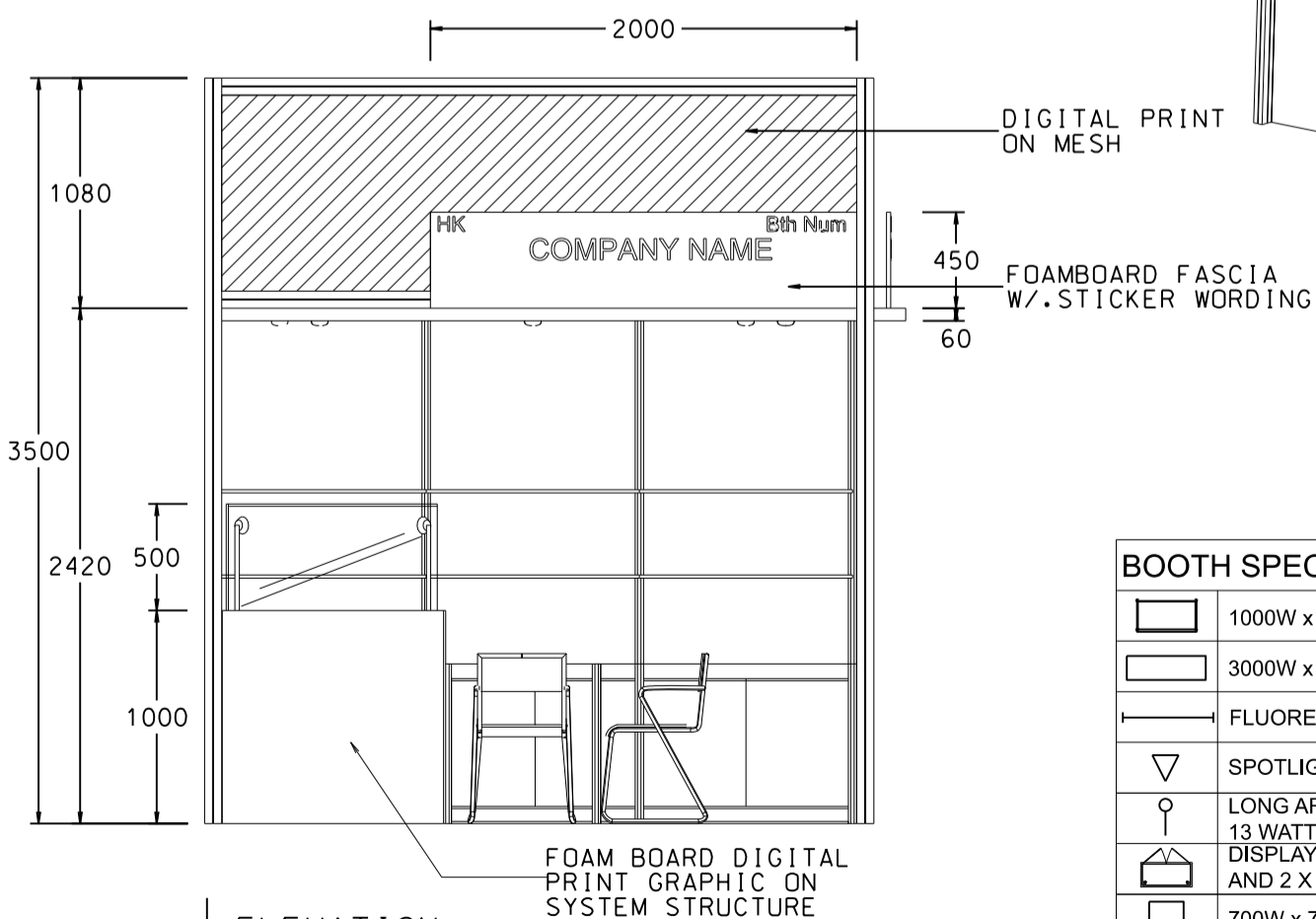

ELEVATION

BOOTH SPECIFICATIONS		QTY.
	1000W x 500D x 750H LOCKABLE CABINET	3
	3000W x 300D WOODEN DISPLAY SHELF	2
	FLUORESCENT TUBE (FOR FASCIA ONLY)	8
	SPOTLIGHT 13 WATT LED LAMP (YELLOW LIGHT)	3
	LONG ARMED SPOTLIGHT (300MM) 13 WATT LED LAMP (YELLOW LIGHT)	2
	DISPLAY SHOWCASE W/. STICKER FIN. AND 2 X 50W TRACKLIGHT	1
	700W x 700D x 750H MEETING TABLE	1
	BLACK LEATHER CHAIR	3
	CEILING BEAM	3M
	RUBBISH BIN & CARPET (9sqm.)	

Hong Kong Houseware Fair

香港家庭用品展

3M x 3M WORLD OF FINE DINING RIGHT CORNER BOOTH (UNDER FIRE CURTAIN)

三米乘三米右邊角位攤位(防火閘下)

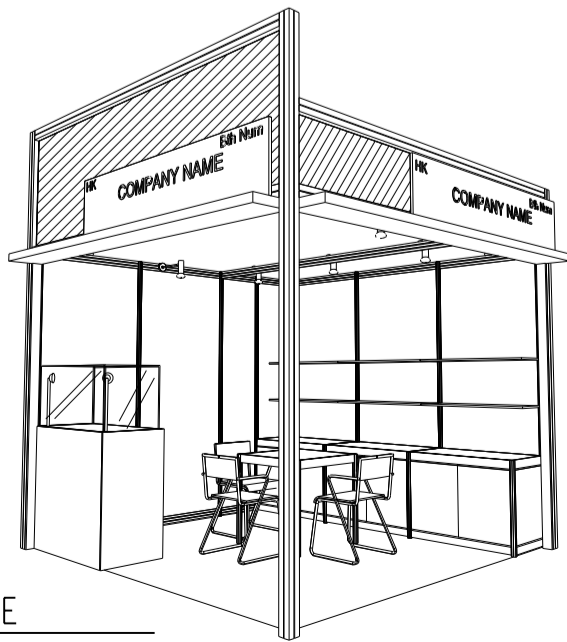
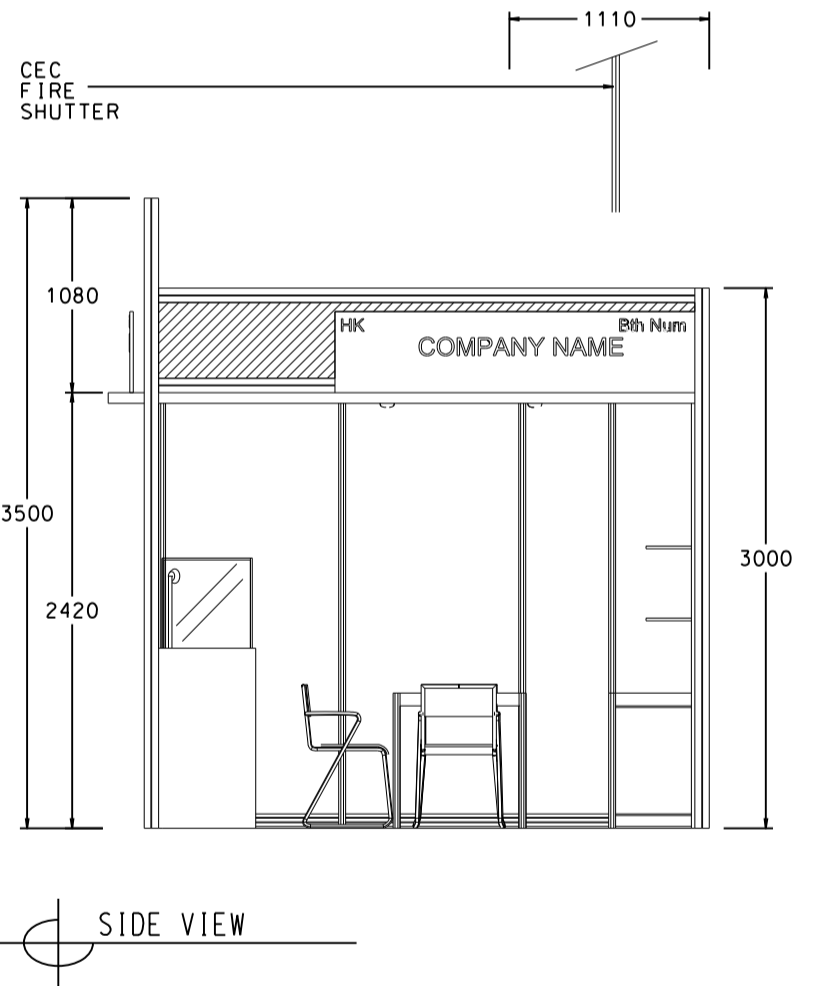
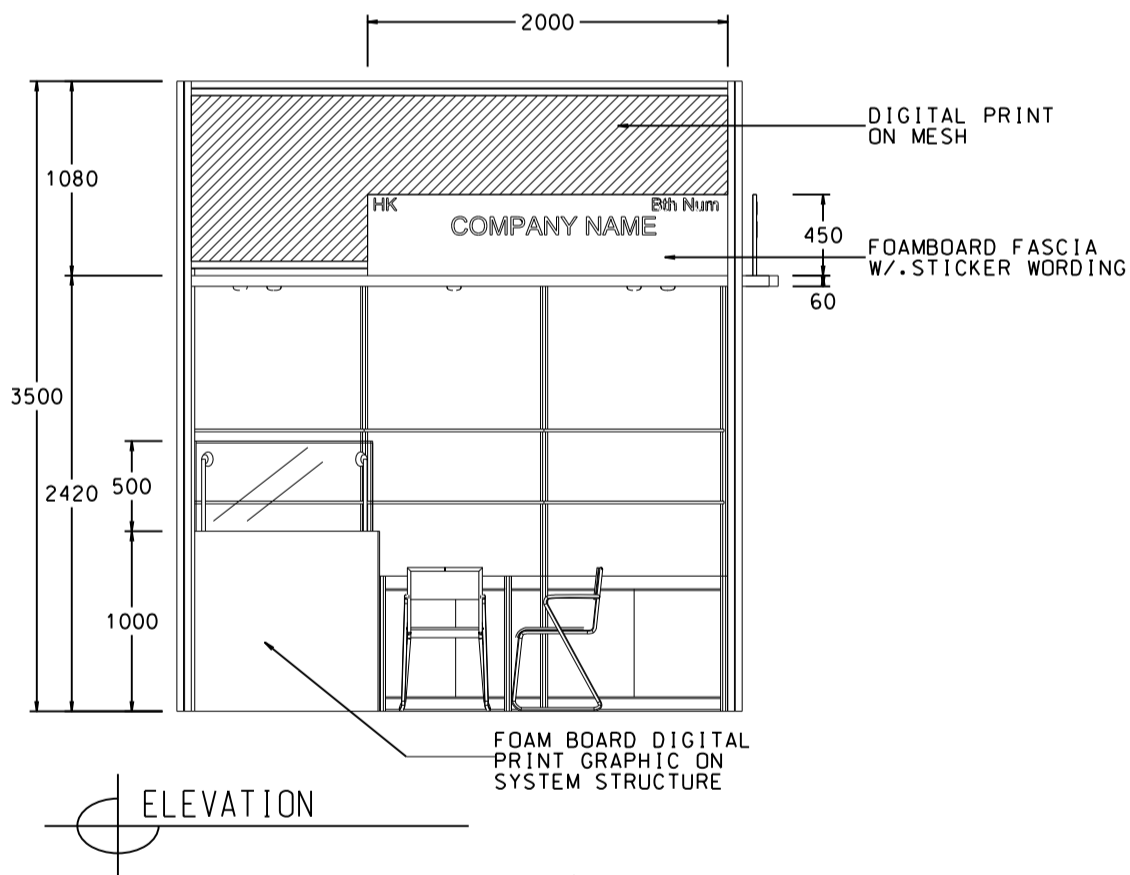
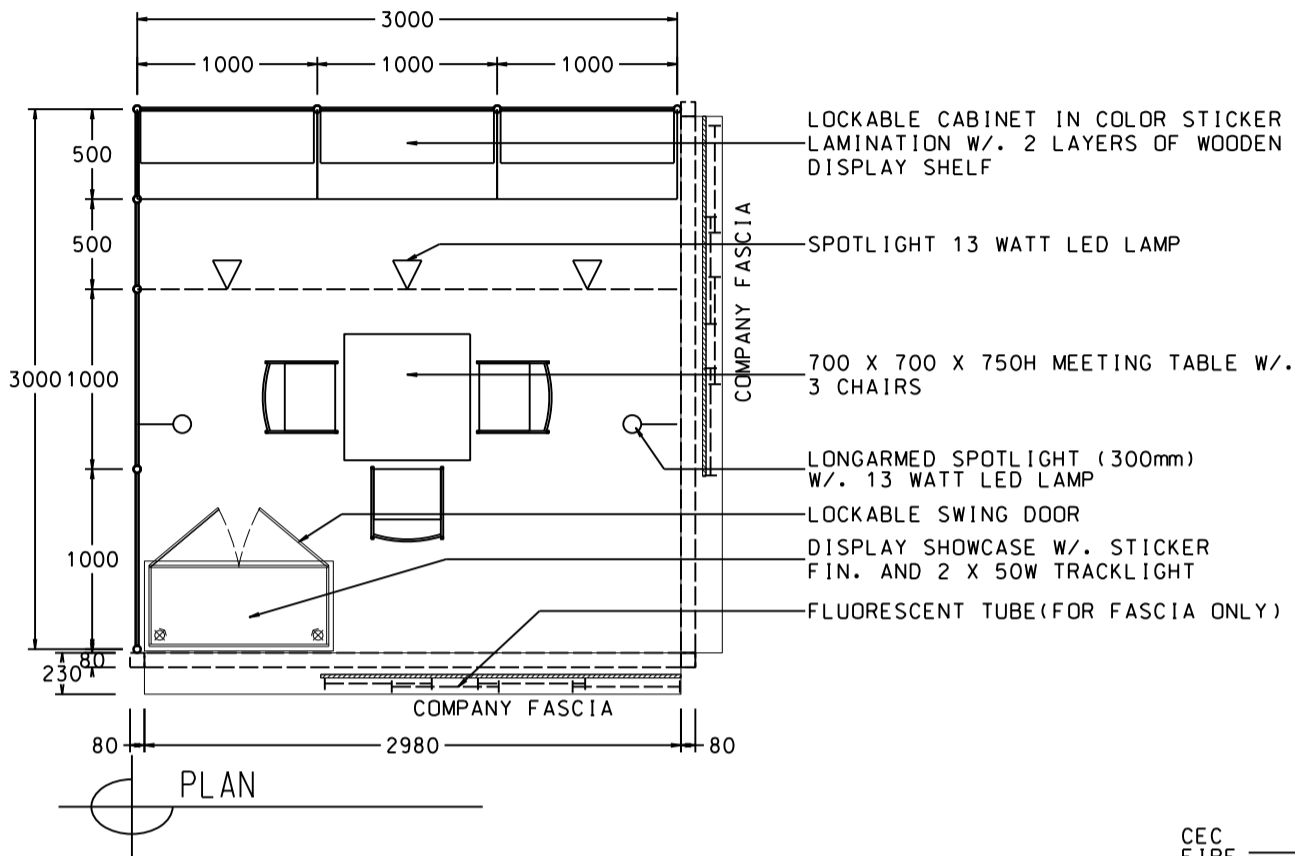

BOOTH SPECIFICATIONS		QTY.
	1000W x 500D x 750H LOCKABLE CABINET	3
	3000W x 300D WOODEN DISPLAY SHELF	2
	FLUORESCENT TUBE (FOR FASCIA ONLY)	8
	SPOTLIGHT 13 WATT LED LAMP (YELLOW LIGHT)	3
	LONG ARMED SPOTLIGHT (300MM) 13 WATT LED LAMP (YELLOW LIGHT)	2
	DISPLAY SHOWCASE W/. STICKER FIN. AND 2 X 50W TRACKLIGHT	1
	700W x 700D x 750H MEETING TABLE	1
	BLACK LEATHER CHAIR	3
	CEILING BEAM	3M
	RUBBISH BIN & CARPET (9sqm.)	

*The Hong Kong Trade Development Council reserves the right to change the configuration if necessary.

*如有需要，香港貿易發展局有權更改攤位結構。

Hong Kong Houseware Fair

香港家庭用品展

3M x 3M WORLD OF FINE DINING PENINSULA BOOTH

三米乘三米半島攤位

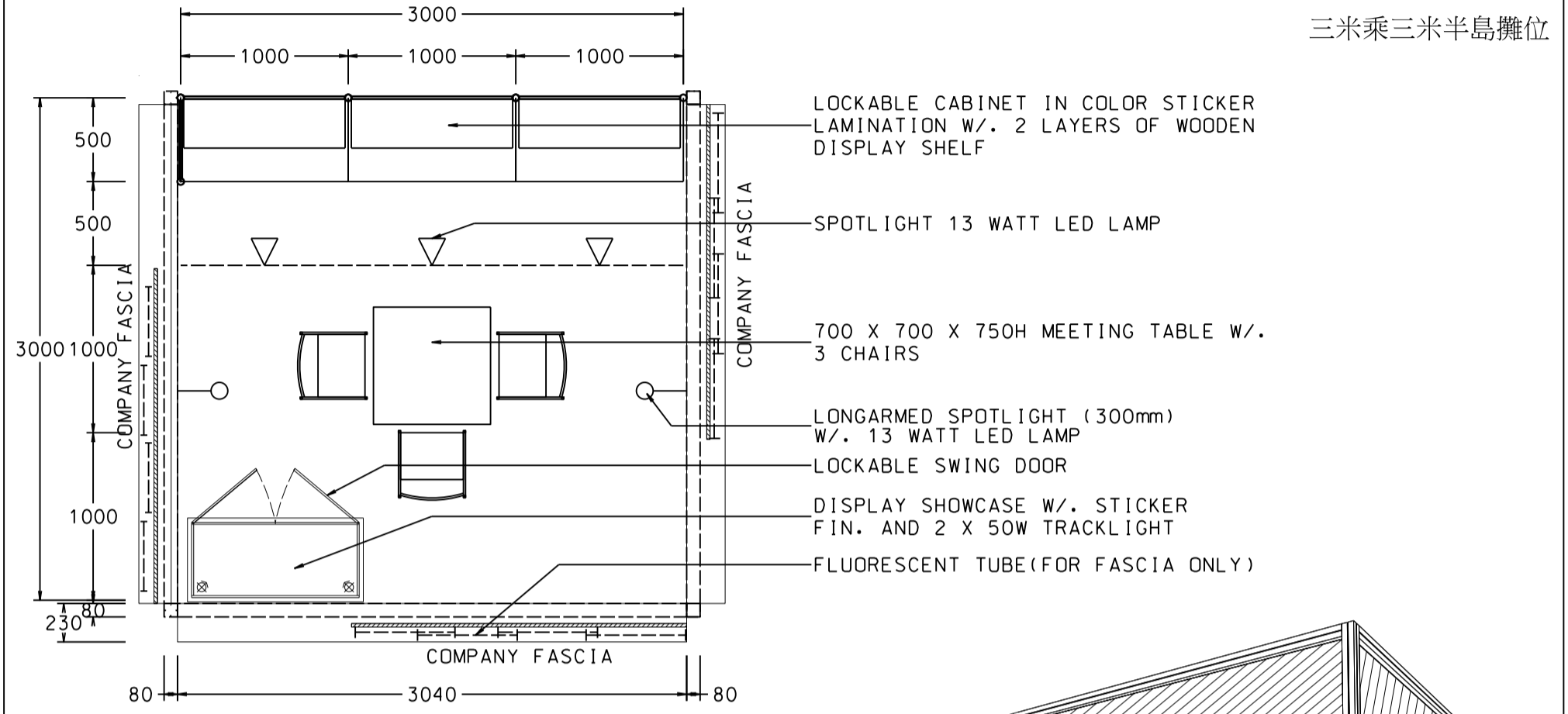

PLAN

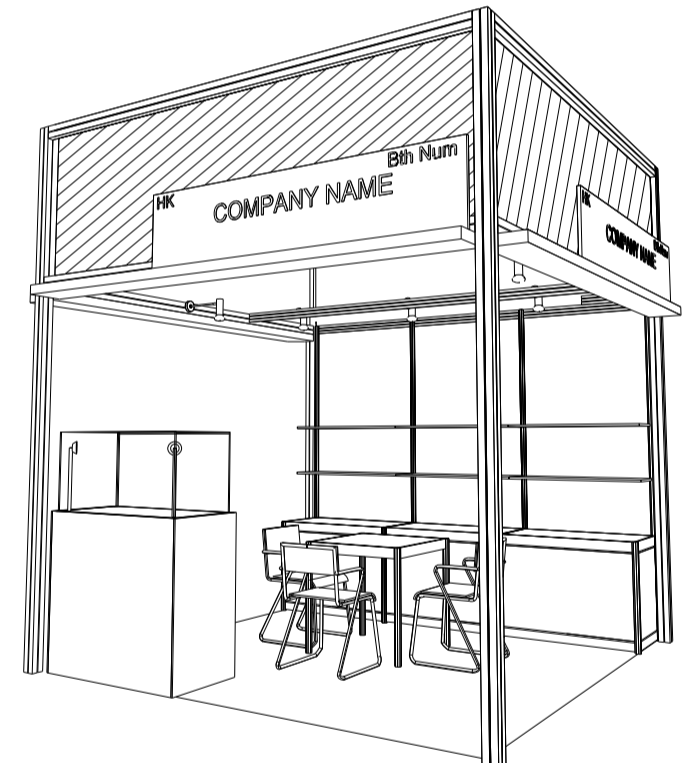

PERSPECTIVE

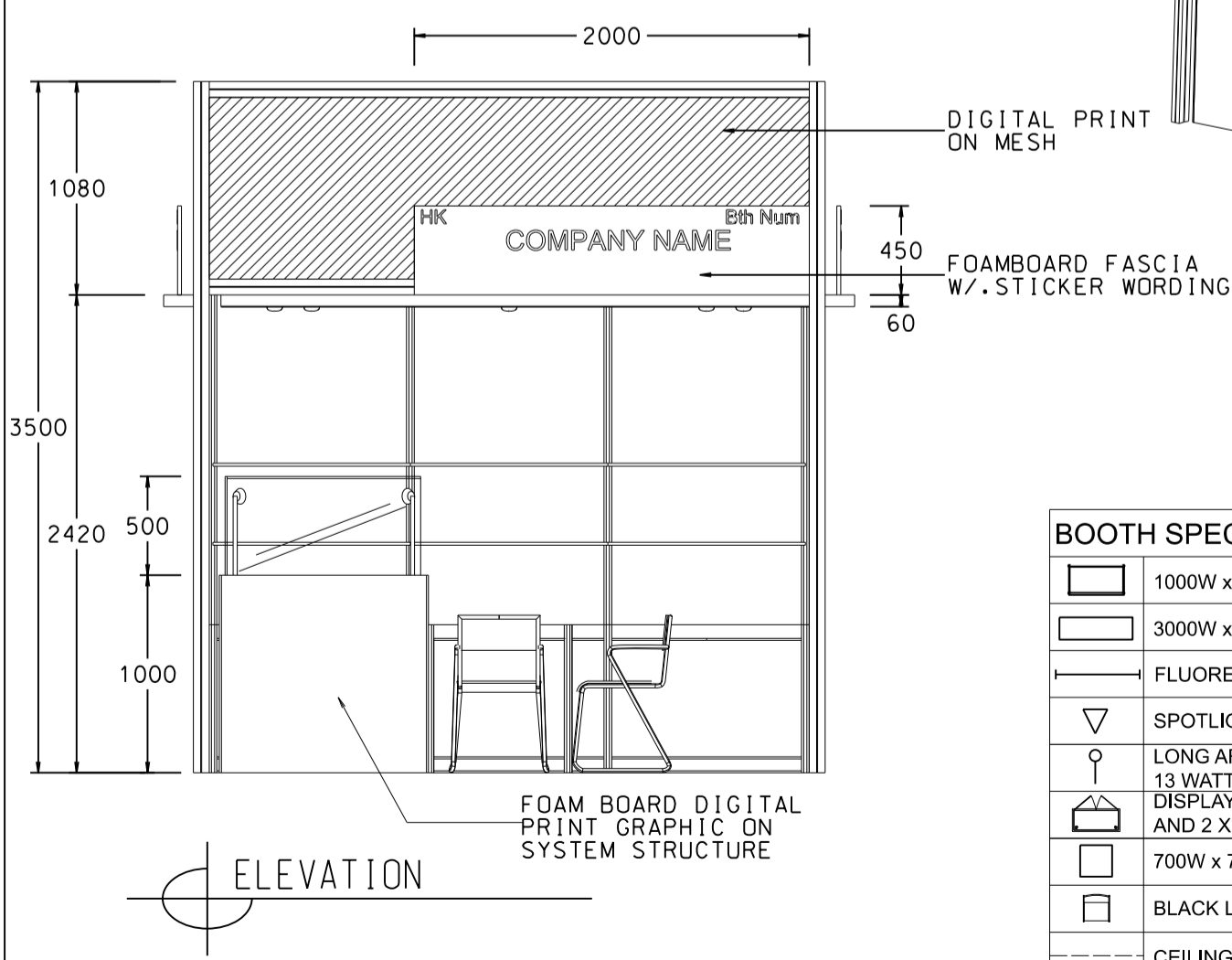

ELEVATION

BOOTH SPECIFICATIONS		QTY.
	1000W x 500D x 750H LOCKABLE CABINET	3
	3000W x 300D WOODEN DISPLAY SHELF	2
	FLUORESCENT TUBE (FOR FASCIA ONLY)	12
	SPOTLIGHT 13 WATT LED LAMP (YELLOW LIGHT)	3
	LONG ARMED SPOTLIGHT (300MM) 13 WATT LED LAMP (YELLOW LIGHT)	2
	DISPLAY SHOWCASE W/. STICKER FIN. AND 2 X 50W TRACKLIGHT	1
	700W x 700D x 750H MEETING TABLE	1
	BLACK LEATHER CHAIR	3
	CEILING BEAM	3M
	RUBBISH BIN & CARPET (9sqm.)	

*The Hong Kong Trade Development Council reserves the right to change the configuration if necessary.
*如有需要，香港貿易發展局有權更改攤位結構。

Hong Kong Houseware Fair

香港家庭用品展

3M x 3M WORLD OF FINE DINING PENINSULA BOOTH (UNDER FIRE CURTAIN)

三米乘三米半島攤位(防火閘下)

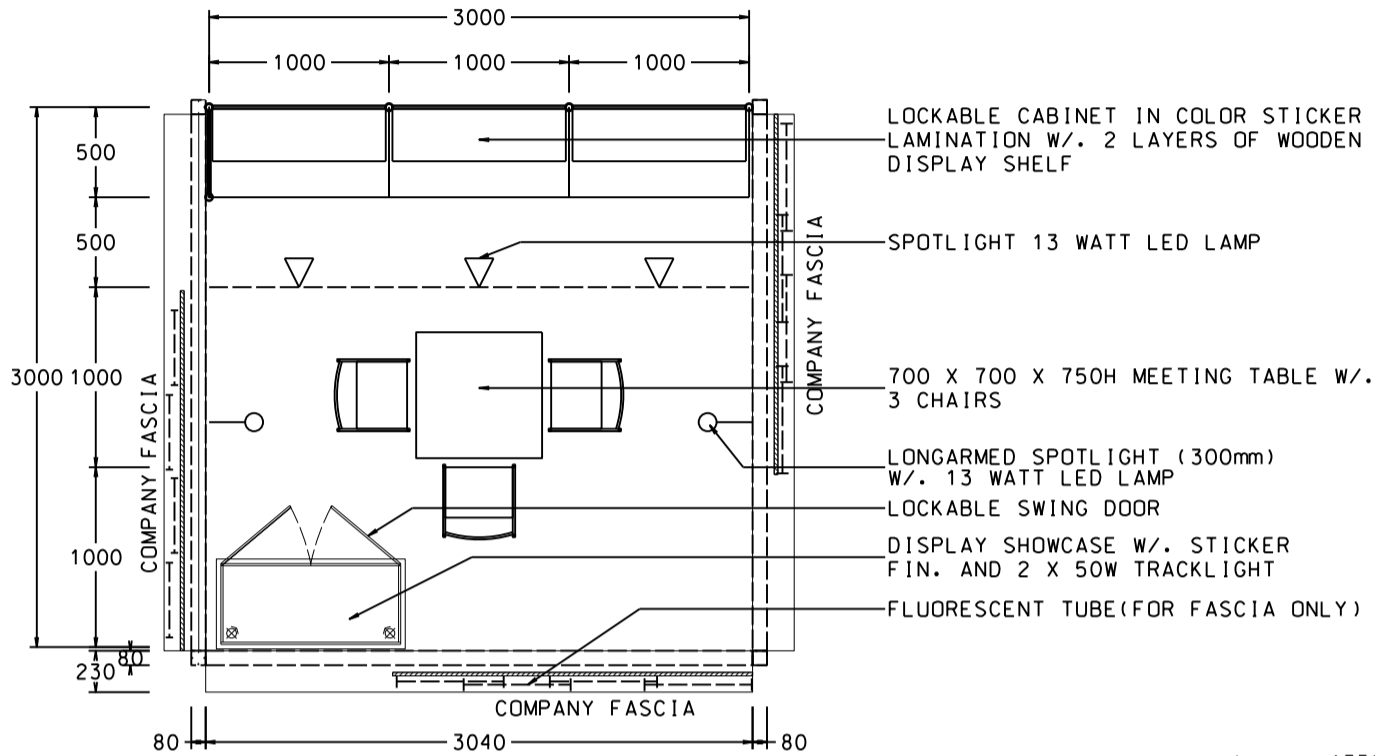

PLAN

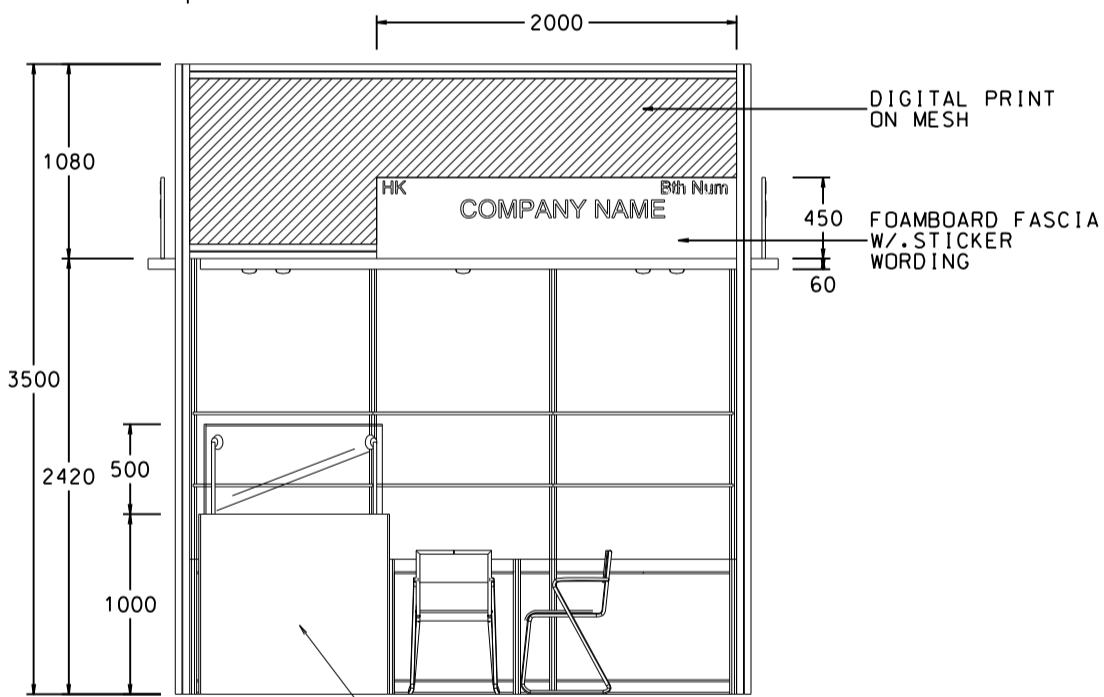

ELEVATION

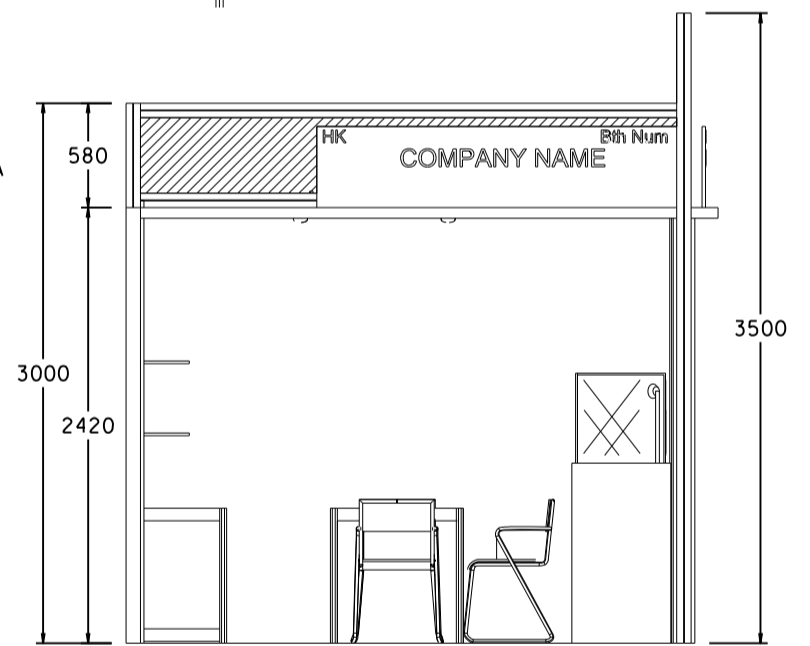

SIDE VIEW

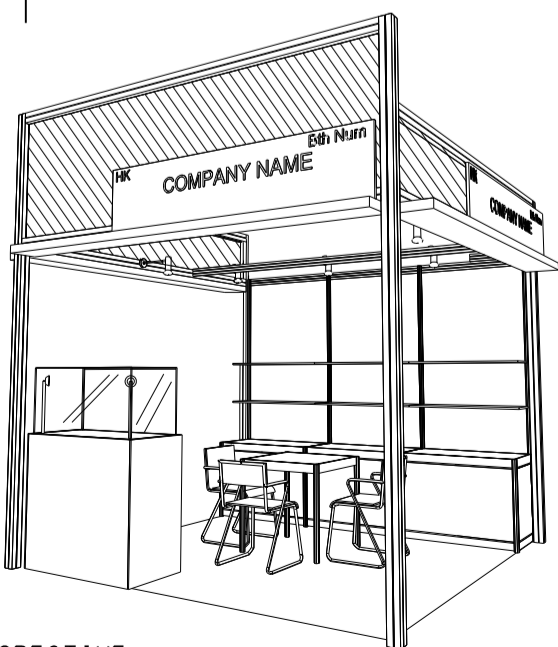

PERSPECTIVE

BOOTH SPECIFICATIONS		QTY.
	1000W x 500D x 750H LOCKABLE CABINET	3
	3000W x 300D WOODEN DISPLAY SHELF	2
	FLUORESCENT TUBE (FOR FASCIA ONLY)	12
	SPOTLIGHT 13 WATT LED LAMP (YELLOW LIGHT)	3
	LONG ARMED SPOTLIGHT (300MM) 13 WATT LED LAMP (YELLOW LIGHT)	2
	DISPLAY SHOWCASE W/. STICKER FIN. AND 2 X 50W TRACKLIGHT	1
	700W x 700D x 750H MEETING TABLE	1
	BLACK LEATHER CHAIR	3
	CEILING BEAM	3M
	RUBBISH BIN & CARPET (9sqm.)	